



DTH Hammers & Bits

- DTH Hammer ----- PAGE 02
- DTH Bits ----- PAGE 18
- Drill Pipes ----- PAGE 26
- Adapters ----- PAGE 26
- Breakout Bench ----- PAGE 27

Selecting The Right Hammer

The optimum range of hole size for blast hole drilling with DTH is 90 mm to 254 mm (3 ½"–10"). Smaller blast holes are generally drilled using tophammer, and larger holes generally use rotary machines. In other applications, like foundation drilling, DTH hammers can be used with single bit in hole sizes up to 914 mm (36"). With multiple hammer units CD (Cluster Drills) drill holes up to 70" or 1778 mm as standard. Larger cluster drills can be delivered as per customer request. As a rule of thumb, the smallest hole diameter a DTH hammer can drill is its nominal size. A 4 inch hammer will drill a 4 inch (102 mm) hole. The limiting factor is the outside diameter of the hammer, because, as hole diameter reduces, airflow is restricted. Maximum hole size for production drilling is the nominal hammer size plus 1 inch, so for a 4 inch hammer the maximum hole size is 5 inch (127–130 mm). Choosing the right hammer is largely determined by hole size and type of rock formation. Ideally, the size of the hammer should match the required hole dimension as closely as possible, leaving just enough space for cuttings to evacuate the hole.

Product codes

Product codes are a valuable tool to describe and identify the product. In the code structure we have tried to describe the product features with Alfa-numerical system and not always 100% logical, but with the attached key you will be able find the product you are looking for or an alternative product.

Example A: HK8Q-H

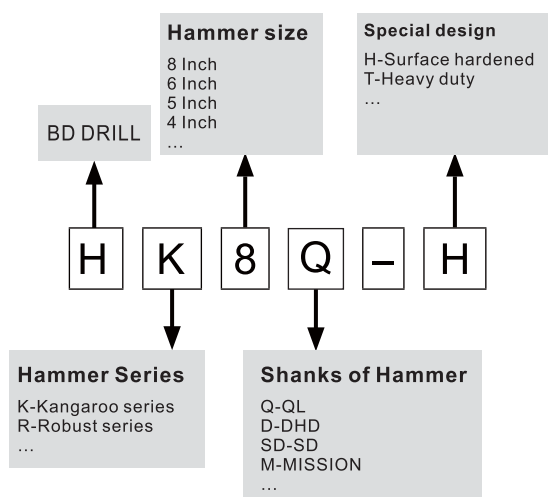

Example B: HQL6A-H

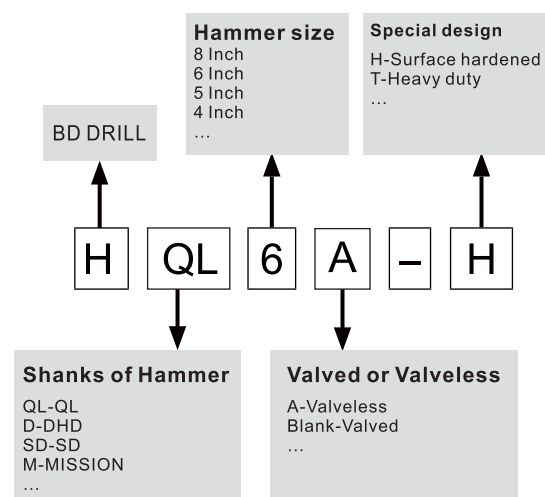

SPECIFICATIONS

Hammer	BR2A	DHD3.5	HK4D	HD45	HQL4A	HQL50	HK5Q	HD55	HQL60	HQL6A	HK8Q	HD85	HK9Q
Recommended bit size, mm	76	92-105	112-127			140-152			165-178		203-229		216-229
Bit shank	BR2A	DHD3.5	DHD340A		QL40	QL50		DHD350	QL60		QL80	DHD380	QL80
External diameter, mm	63	82	100	100	101	126.5	127.5	126.5	148	146	185	185	203
Length excl. thread, mm (Less bit)	837	855	915	1032.5	1057	1147	935	1167	1121	1182	1340	1487	1345
Hammer weight, kg (Less bit)	14.1	25	37.5	40.6	41	71.6	67.6	77.2	105	105	180	206	228
Package case size	(L)910 (W)90 (H)120	(L)1020 (W)110 (H)140	(L)1010 (W)130 (H)160	(L)1080 (W)125 (H)145	(L)1150 (W)130 (H)160	(L)1230 (W)155 (H)180	(L)1100 (W)155 (H)180	(L)1290 (W)150 (H)175	(L)1270 (W)170 (H)200	(L)1260 (W)180 (H)200	(L)1440 (W)230 (H)270	(L)1560 (W)230 (H)270	(L)1500 (W)240 (H)280
Top sub thread	RD50	2-3/8" API REG							3-1/2" API REG		4-1/2" API REG		
Working pressure, PSI	80-170	150-250	200-300			250-350			300-350		300-380		
Air consumption CFM	250-350	300-400	500-700			500-800			600-900		950-1200		
Piston diameter, mm	42.7	65	82	80	80	104	102	100	122	121	150	150	165
Piston weight, kg	1.7	5.1	9.2	9	9	17	17	16	24	24	38	42	50
Wrench flat, mm	L47 W50	L57 W35	L74.5 W45	L64 W40	NO wrench flat	L89 W60	L88 W50	L89 W60	L101 W65	L101 W60	L128 W70	L140 W70	L128 W70
Feed force, kN	2~6	3~8	5~15			6~25			7~20		10~25		
Rotation speed, r/m	30-70	30-90	25-80			20-70			25-60		20-60		
Drilling conditions and project specifications may require larger air package to be used													

AIR CONSUMPTION/OPERATING PRESSURE

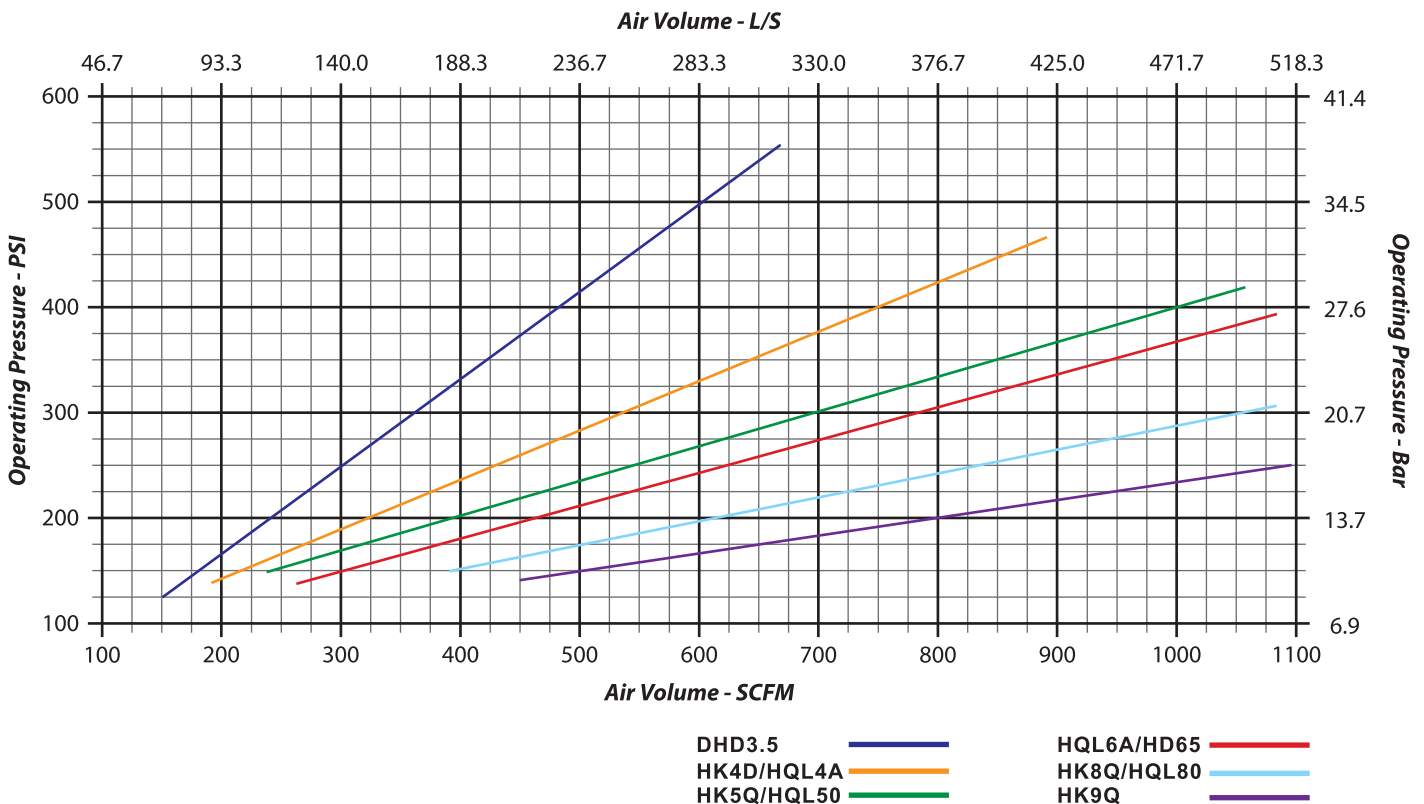

BR2A DTH HAMMER

BR2A. Hammers	Item Description	Weight (Kg)	Part Number
	1 Top Sub	2.95	BR2A-TSUB
	2 Check Valve	0.10	BR2A-CVALVE
	3 Spring	0.05	BR2A-SPRING
	4 Air Distributor	0.40	BR2A-DIST
	5 Internal Cylinder	0.85	BR2A-ICYL
	6 Piston	2.70	BR2A-PISTON
	7 External Cylinder	5.35	BR2A-ECYL
	8 Guided Sleeve	0.55	BR2A-BUSH
	9 "O" Ring Stop Ring	0.005	BR2A-SR-SRING
	10 Stop Ring	0.10	BR2A-SRING
	11 Drive Chuck	1.05	BR2A-DCHUCK
	12 Drill Bit		BR2A-76FF-TV

Technical Data

Length(Less bit)	Weigth(Less bit)	External Diameter	Bit Shank	Hole Range	Connection Thread
880mm	14.1kg	Φ62mm	BR2	Φ76-Φ90	RD 50 BOX
Box Size	Impact rate at 1.7Mpa	Recommended rotation speed	Air Consumption		
			80-170(PSI)		
910x90x120mm	25HZ	25-40r/min	250-350(CFM)		

HD35 DTH HAMMER

HD35.Hammers	Item Description	Weight (Kg)	Part Number	
	1	Top Sub	4.20	HD35-TSUB
	2	"O" Ring of Top Sub	0.01	HD35-SR-TUSB
	3	Check Valve	0.20	HD35-CVALVE
	4	Spring	0.02	HD35-SPRING
	5	Compression Buffer	0.02	HD35-CBUFFER
	6	Air Distributor	1.40	HD35-DIST
	7	Internal Cylinder	1.50	HD35-ICYL
	8	Piston	5.60	HD35-PISTON
	9	External Cylinder	9.90	HD35-ECYL
	10	"O"Ring of Stop Ring	0.01	HD35-SR-RING
	11	Stop Ring	0.15	HD35-SRING
	12	Drive Chuck	1.90	HD35-DCHUCK
	13	Drill Bit		HD35-90FF-TV

Technical Data

Length(Less bit)	Weigth(Less bit)	External Diameter	Bit Shank	Hole Range	Connection Thread
930mm	24.4Kg	Φ82	DHD3.5 HD35	Φ92-Φ105	API 2 3/8 " REG
Box Size	Impact rate at 1.7Mpa	Recommended rotation speed		Air Consumption	
1020x110x140mm	28HZ	25-40r/min		150-250(PSI)	
				300-400(CFM)	

HK4-D DTH HAMMER

HK4-D. Hammers	Item Description	Weight (Kg)	Part Number
	1 Top Sub	6.50	HK4-D-TSUB
	2 "O"Ring of Top Sub	0.01	HK4-D-SR-TSUB
	3 Check Valve	0.35	HK4-D-CVALVE
	4 Spring	0.05	HK4-D-SPRING
	5 Compression Buffer	0.15	HK4-D-CBUFFER
	6 Air Distributor	2.10	HK4-D-DIST
	7 Internal Cylinder	2.25	HK4-D-ICYL
	8 Piston	8.50	HK4-D-PISTON
	9 External Cylinder	15.2	HK4-D-ECYL
	10 Guided Sleeve	1.30	HK4-D-BUSH
	11 "O"Ring of Stop Ring	0.01	HK4-D-SR-SRING
	12 Stop Ring	0.30	HK4-D-SRING
	13 Drive Chuck	3.40	HK4-D-DCHUCK
	14 Drill Bit		HK4-D-110FF-TV

Technical Data

Length(Less bit)	Weigth(Less bit)	External Diameter	Bit Shank	Hole Range	Connection Thread
922mm	38.0Kg	Φ100	DHD340A Cop44	Φ112-Φ127	API 2 3/8 " REG
Box Size	Impact rate at 1.7Mpa	Recommended rotation speed	Air Consumption		
			200-300(PSI)		
1010x130x160mm	25HZ	30-70r/min	500-700(CFM)		

HD45 DTH HAMMER

HD45. Hammers	Item Description	Weight (Kg)	Part Number	
	1	Top Sub	6.50	HD45-TSUB
	2	"O"Ring of Top Sub	0.01	HD45-SR-TSUB
	3	Check Valve	0.42	HD45-CVALVE
	4	Spring	0.04	HD45-SPRING
	5	Compression Buffer	0.04	HD45-CBUFFER
	6	Air Distributor	2.20	HD45-DIST
	7	Internal Cylinder	2.30	HD45-ICYL
	8	Piston	9.00	HD45-PISTON
	9	External Cylinder	15.8	HD45-ECYL
	10	"O" Ring of Stop Ring	0.01	HD45-SR-SRING
	11	Stop Ring	0.20	HD45-SRING
	12	Drive Chuck	3.50	HD45-DCHUCK
	13	Drill Bit		HD45-115FF-TV

Technical Data

Length(Less bit)	Weigth(Less bit)	External Diameter	Bit Shank	Hole Range	Connection Thread
1030mm	40.0Kg	Φ99	Cop44 DHD340 HD45	Φ112-Φ127	API 3 1/2 " REG
Box Size	Impact rate at 1.7Mpa	Recommended rotation speed	Air Consumption		
			200-300(PSI)		
1150x130x160mm	27HZ	25-40r/min	500-700(CFM)		

HQL40A DTH HAMMER

HQL4A. Hammers	Item Description	Weight (Kg)	Part Number	
	1	Top Sub	6.50	HQL40A-TSUB
	2	"O"Ring of Top Sub	0.01	HQL40A-SR-TSUB
	3	Check Valve	0.35	HQL40A-CVALVE
	4	Spring	0.05	HQL40A-SPRING
	5	Air Distributor	1.50	HQL40A-CBUFFER
	6	Internal Cylinder	2.10	HQL40A-DIST
	7	Piston	8.50	HQL40A-ICYL
	8	External Cylinder	15.20	HQL40A-PISTON
	9	Guided Sleeve	1.80	HQL40A-ECYL
	10	"O" Ring of Stop Ring	0.005	HQL40A-SR-SRING
	11	Stop Ring	0.20	HQL40A-SRING
	12	Drive Chuck	3.20	HQL40A-DCHUCK
	13	Drill Bit		HQL40A-115FF-TV

Technical Data

Length(Less bit)	Weigth(Less bit)	External Diameter	Bit Shank	Hole Range	Connection Thread
1070mm	40.0Kg	Φ99	QL40 HQL40	Φ112-Φ127	API 2 3/8 " REG
Box Size	Impact rate at 1.7Mpa	Recommended rotation speed	Air Consumption		
			200-300(Psi)		
1230x155x180mm	30HZ	25-40r/min	500-700(CFM)		

HQL50 DTH HAMMER

HQL50. Hammers	Item Description	Weight (Kg)	Part Number
----------------	------------------	-------------	-------------

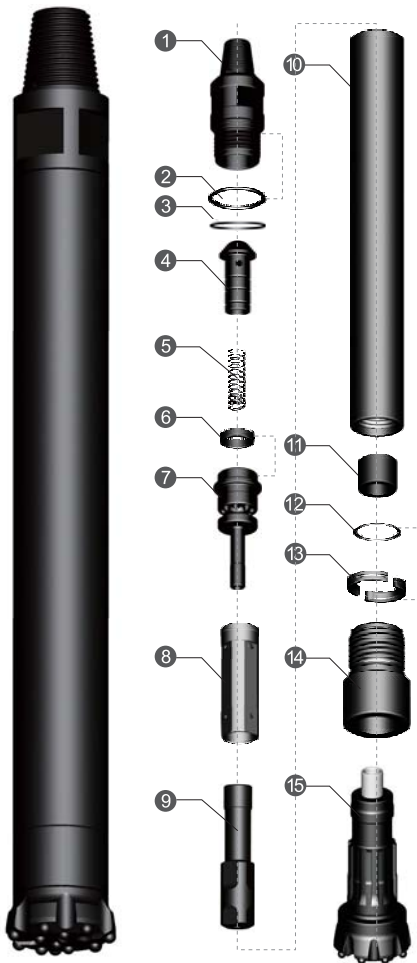

1	Top Sub	15.0	HQL50-TSUB
2	"O"Ring of Top Sub	0.015	HQL50-SR-TSUB
3	Breakout Ring of Top Sub	0.15	HQL50-BR-TSUB
4	Check Valve	1.00	HQL50-CVALVE
5	Spring	0.10	HQL50-SPRING
6	Compression Buffer	0.10	HQL50-CBUFFER
7	Air Distributor	3.50	HQL50-DIST
8	Internal Cylinder	4.20	HQL50-ICYL
9	Piston	19.0	HQL50-PISTON
10	External Cylinder	24.6	HQL50-ECYL
11	Guided Sleeve	0.90	HQL50-BUSH
12	"O"Ring of Stop Ring	0.01	HQL50-SR-SRING
13	Stop Ring	0.40	HQL50-SRING
14	Drive Chuck	4.60	HQL50-DCHUCK
15	Drill Bit		HQL50-135FF-TV

Technical Data

Length(Less bit)	Weigth(Less bit)	External Diameter	Bit Shank	Hole Range	Connection Thread
1156mm	73.0Kg	Φ125	Cop54-G QL50 HQL50	Φ140-Φ152	API 3 1/2 " REG
Box Size	Impact rate at 1.7Mpa	Recommended rotation speed	Air Consumption		
			250-350(PSI)		
1230x155x180mm	25HZ	20-35r/min	500-800(CFM)		

HK5-Q DTH HAMMER

HK5-Q. Hammers	Item Description	Weight (Kg)	Part Number
----------------	------------------	-------------	-------------

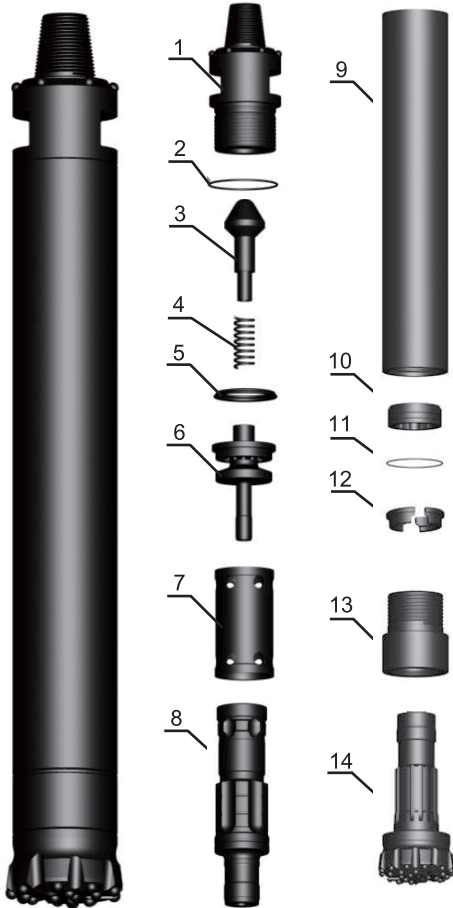

1	Top Sub	13.7	HK5-Q-TSUB
2	"O"Ring of Top Sub	0.01	HK5-Q-SR-TSUB
3	Check Valve	0.60	HK5-Q-CVALVE
4	Spring	0.10	HK5-Q-SPRING
5	Compression Buffer	0.20	HK5-Q-CBUFFER
6	Air Distributor	2.00	HK5-Q-DIST
7	Internal Cylinder	2.70	HK5-Q-ICYL
8	Piston	13.0	HK5-Q-PISTON
9	External Cylinder	22.5	HK5-Q-ECYL
10	Guided Sleeve	3.00	HK5-Q-BUSH
11	Retaining Ring	0.10	HK5-Q-RRING
12	Stop Ring	0.65	HK5-Q-SRING
13	Drive Chuck	4.50	HK5-Q-DCHUCK
14	Drill Bit		HK5-Q-135FF-TV

Technical Data

Length(Less bit)	Weighth(Less bit)	External Diameter	Bit Shank	Hole Range	Connection Thread
935mm	65.0Kg	Φ126	QL50	Φ140-Φ152	API 3 1/2 " REG
Box Size	Impact rate at 1.7Mpa	Recommended rotation speed	Air Consumption		
			250-350(Psi)		
1100x155x180mm	25HZ	30-70r/min	500-800(CFM)		

HD55 DTH HAMMER

HD55. Hammers	Item Description	Weight (Kg)	Part Number
---------------	------------------	-------------	-------------

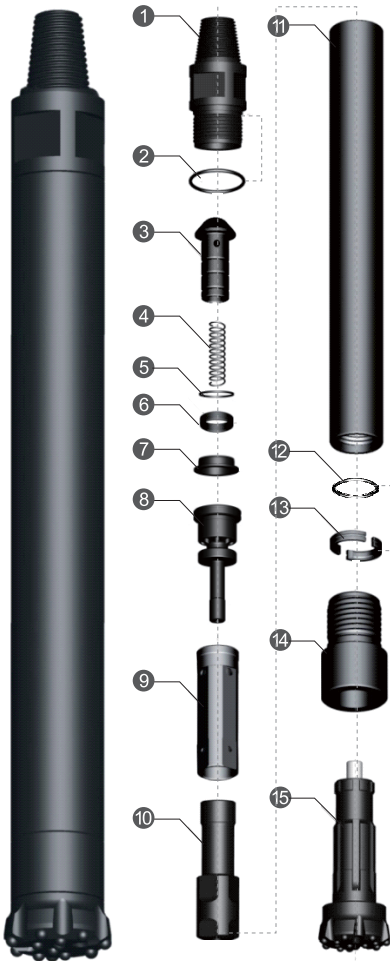

1	Top Sub	15.0	HD55-TSUB
2	"O"Ring of Top Sub	0.01	HD55-SR-TSUB
3	Check Valve	1.00	HD55-CVALVE
4	Spring	0.04	HD55-SPRING
5	Ring	0.10	HD55-RING
6	Compression Buffer	0.06	HD55-CBUFFER
7	Compression Buffer Seat	0.40	HD55-SBS
8	Air Distributor	4.00	HD55-DIST
9	Internal Cylinder	4.70	HD55-ICYL
10	Piston	15.50	HD55-PISTON
11	External Cylinder	30.00	HD55-ECYL
12	"O" Ring of Stop Ring	0.01	HD55-SR-SRING
13	Stop Ring	0.30	HD55-SRING
14	Drive Chuck	6.40	HD55-DCHUCK
15	Drill Bit		HD55-140FF-TV

Technical Data

Length(Less bit)	Weigth(Less bit)	External Diameter	Bit Shank	Hole Range	Connection Thread
1214mm	77.5Kg	Φ125mm	Cop54 DHD350R HD55	Φ140-Φ152	API 2 3/8" REG API 3 1/2" REG
Box Size	Impact rate at 1.7Mpa	Recommended rotation speed	Air Consumption		
			250-350(Psi)		
1290x150x175mm	25HZ	20-35r/min	500-800(CFM)		

HQL60 DTH HAMMER

HQL60. Hammers	Item Description	Weight (Kg)	Part Number
----------------	------------------	-------------	-------------

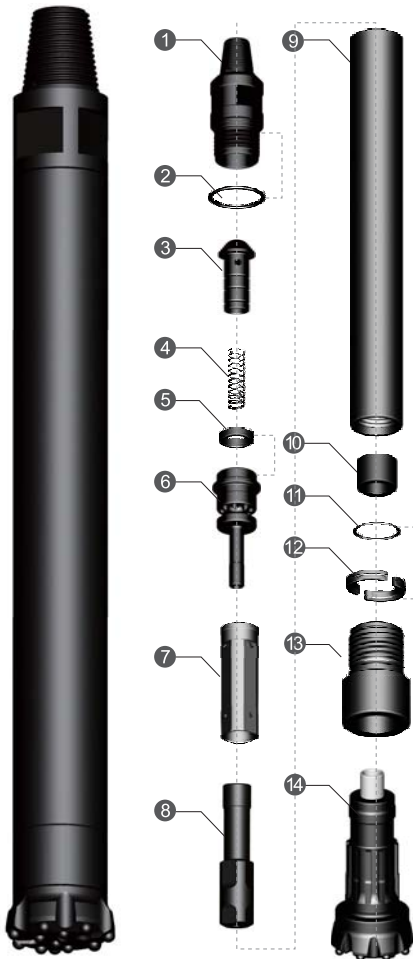

1	Top Sub	20.00	HQL60-TSUB
2	"O"Ring of Top Sub	0.02	HQL60-SR-TSUB
3	Check Valve	1.00	HQL60-CVALVE
4	Spring	0.10	HQL60-SPRING
5	Compression Buffer	0.10	HQL60-CBUFFER
6	Air Distributor	6.00	HQL60-DIST
7	Internal Cylinder	5.00	HQL60-ICYL
8	Piston	23.50	HQL60-PISTON
9	External Cylinder	31.00	HQL60-ECYL
10	Guided Sleeve	1.00	HQL60-BUSH
11	"O"Ring of Stop Ring	0.02	HQL60-SR-RING
12	Stop Ring	0.60	HQL60-SRING
13	Drive Chuck	5.40	HQL60-DCHUCK
14	Drill Bit		HQL60-165CC-TV

Technical Data

Length(Less bit)	Weigth(Less bit)	External Diameter	Bit Shank	Hole Range	Connection Thread
1212mm	95. 0Kg	Φ148mm	Cop64-G QL 60 HQL 60	Φ165-Φ178	API 3 1/2 " REG
Box Size	Impact rate at 1.7Mpa	Recommended rotation speed	Air Consumption		
			300-350(PSI)		
1270x170x200mm	23HZ	20-30r/min	600-900(CFM)		

HQL60A DTH HAMMER

HQL60A. Hammers	Item Description	Weight (Kg)	Part Number	
	1	Top Sub	20.00	HQL60A-TSUB
	2	"O"Ring of Top Sub	0.015	HQL60A-SR-TSUB
	3	Check Valve	0.70	HQL60A-CVALVE
	4	Spring	0.10	HQL60A-SPRING
	5	Air Distributor	3.50	HQL60A-DIST
	6	Internal Cylinder	4.20	HQL60A-ICYL
	7	Piston	23.00	HQL60A-PISTON
	8	External Cylinder	30.00	HQL60A-ECYL
	9	Guided Sleeve	4.00	HQL60A-BUSH
	10	"O"Ring of Stop Ring	0.01	HQL60A-SR-RING
	11	Stop Ring	0.60	HQL60A-SRING
	12	Drive Chuck	5.50	HQL60A-DCHUCK
	13	Drill Bit		HQL60A-165CC-TV

Technical Data

Length(Less bit)	Weigth(Less bit)	External Diameter	Bit Shank	Hole Range	Connection Thread
1183mm	92.0Kg	Φ148mm	QL60 HQL60A	Φ165-Φ178	API 3 1/2" Reg
Box Size	Impact rate at 1.7Mpa	Recommended rotation speed	Air Consumption		
			300-350(PSI)		
1260x180x200mm	25HZ	20-30r/min	600-900(CFM)		

HK8-Q DTH HAMMER

HK8-Q. Hammers	Item Description	Weight (Kg)	Part Number
	1 Top Sub	34.0	HK8-Q--TSUB
	2 "O"Ring of Top Sub	0.02	HK8-Q-SR-TSUB
	3 Check Valve	0.95	HK8-Q-CVALVE
	4 Spring	0.10	HK8-Q-SPRING
	5 Compression Buffer	0.35	HK8-Q-CBUFFER
	6 Air Distributor	6.05	HK8-Q-DIST
	7 Internal Cylinder	6.25	HK8-Q-ICYL
	8 Piston	38.0	HK8-Q-PISTON
	9 External Cylinder	56.0	HK8-Q-ECYL
	10 Guided Sleeve	5.30	HK8-Q-BUSH
	11 Retaining Ring	0.20	HK8-Q-RRING
	12 Stop Ring	1.90	HK8-Q-SRING
	13 Drive Chuck	13.0	HK8-Q-DCHUCK
	14 Drill Bit		HK8-Q-203CC-TV

Technical Data

Length(Less bit)	Weigth(Less bit)	External Diameter	Bit Shank	Hole Range	Connection Thread
1340mm	172.0Kg	Φ185	QL80	Φ203-Φ229	BECO 4 1/2" REG API 4 1/2" REG
Box Size	Impact rate at 1.7Mpa	Recommended rotation speed	AirConsumption		
			300-380(PSI)		
1440x230x270mm	25HZ	30-70r/min	950-1200(CFM)		

HD85 DTH HAMMER

HD85. Hammers	Item Description	Weight (Kg)	Part Number
---------------	------------------	-------------	-------------

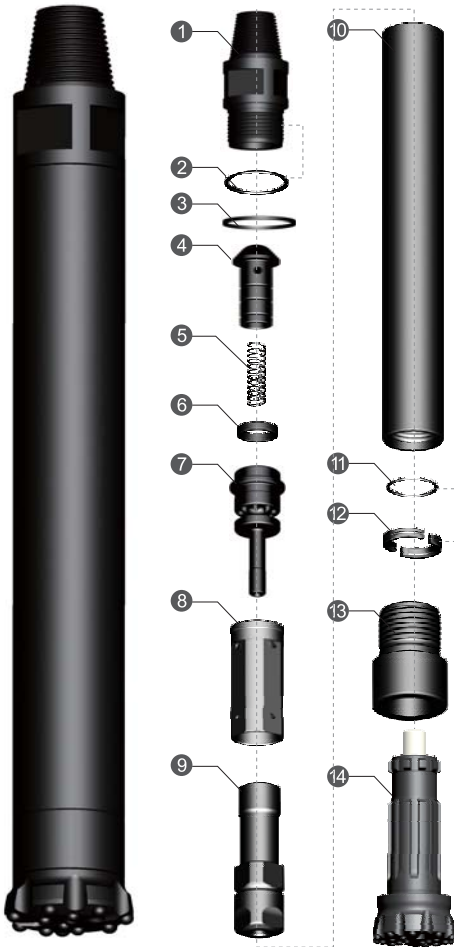

1	Top Sub	41.0	HD85-TSUB
2	"O"Ring of Top Sub	0.02	HD85-SR-TSUB
3	Breakout Ring of Top Sub	0.20	HD85-BR-TSUB
4	Check Valve	1.50	HD85-CVALVE
5	Spring	0.10	HD85-SPRING
6	Compression Buffer	0.42	HD85-CBUFFER
7	Air Distributor	0.13	HD85-DIST
8	Internal Cylinder	8.60	HD85-ICYL
9	Piston	41.0	HD85-PISTON
10	External Cylinder	75.2	HD85-ECYL
11	"O" Ring of Stop Ring	0.02	HD85-SR-SRING
12	Stop Ring	1.20	HD85-SRING
13	Drive Chuck	17.5	HD85-DCHUCK
14	Drill Bit		HD85-195CC-YV

Technical Data

Length(Less bit)	Weigth(Less bit)	External Diameter	Bit Shank	Hole Range	Connection Thread
1492mm	186.9Kg	Φ185mm	Cop84 DHD380 HD85	Φ203-Φ229	API 4 1/2" Reg
Box Size	Impact rate at 1.7Mpa	Recommended rotation speed	Air Consumption		
			300-380(PSI)		
1560x230x270mm	20HZ	20-30r/min	950-1200(CFM)		

HK9-Q DTH HAMMER

HK9-Q. Hammers	Item Description	Weight (Kg)	Part Number	
	1	Top Sub	45.5	HK9-Q-TSUB
	2	"O"Ring of Top Sub	0.02	HK9-Q-SR-TSUB
	3	Breakout Ring	0.55	HK9-Q-BOR
	4	Check Valve	1.20	HK9-Q-CVALVE
	5	Spring	0.15	HK9-Q-SPRING
	6	Compression Buffer	0.45	HK9-Q-CBUFFER
	7	Air Distributor	10.2	HK9-Q-DIST
	8	Internal Cylinder	7.50	HK9-Q-ICYL
	9	Piston	50.0	HK9-Q-PISTON
	10	External Cylinder	79.5	HK9-Q-ECYL
	11	Guided Sleeve	6.20	HK9-Q-BUSH
	12	Retaining Ring	0.30	HK9-Q-RRING
	13	Stop Ring	2.20	HK9-Q-SRING
	14	Breakout Ring	0.55	HK9-Q-BOR
	15	Drive Chuck	23.0	HK9-Q-DCHUCK
	16	Drill Bit		HK9-Q-216CC-TV

Technical Data

Length(Less bit)	Weigth(Less bit)	External Diameter	Bit Shank	Hole Range	Connection Thread
1345mm	205.0Kg	Φ203mm	QL80	Φ216-Φ229	BECO 4 1/2" REG API 4 1/2" REG
Box Size	Impact rate at 2.4Mpa	Recommended rotation speed	Air Consumption		
			300-380(Psi)		
1500x240x280mm	25HZ	30-70r/min	950-1200(CFM)		

HK12-Y DTH HAMMER

HK12-Y. Hammers	Item Description	Weight (Kg)	Part Number
	1 Top Sub	119.5	HK12Y-TSUB
	2 O Ring (Top Sub)	0.02	HK12Y-SK-TSUB
	3 Spacer	1.20	HK12Y-SPACER-A
	4 Check Valve	0.20	HK12Y-CVALVE
	5 Spring	0.50	HK12Y-SPRING
	6 Compression Buffer	2.20	HK12Y-CBUFFER
	7 Air Distributor	19.6	HK12Y-DIST
	8 Internal Cylinder	15.1	HK12Y-ICYL
	9 Piston	111.1	HK12Y-PISTON
	10 External Cylinder	177.1	HK12Y-ECYL
	11 Bearing Bush	19.15	HK12Y-BUSH
	12 Retaining Ring	1.50	HK12Y-RRING
	13 O Ring (Bit Ring)	0.20	HK12Y-SK-SRING
	14 Bit Retaining Ring	4.35	HK12Y-SRING
	15 Spacer	1.20	HK12Y-SPACER-B
	16 Drive Chuck	37.2	HK12Y-DSUB
	17 Drill Bit	108.0	HK12Y-311CC

Technical Data

Length(Less bit)	Weighth(Less bit)	External Diameter	Bit Shank	Hole Range	Connection Thread
1590mm	510.2Kg	Φ275mm	HY12	Φ305-Φ350	API 6 5/8 " REG API 7 5/8 " REG
Box Size	Impact rate at 2.4Mpa	Recommended rotation speed	Air Consumption		
			200-350(PSI)		
1665x320x360mm	19.2HZ	15-35r/min	1200-1500(CFM)		

Selecting the right bit

Black diamond has a comprehensive range of DTH drill bits to match all conceivable applications. Each bit is made from quality alloy steel, and has been precision machined to produce a perfect body, heat treated to the required hardness, given surface compression for fatigue resistance, and fitted with precision buttons manufactured in-house. These are designed for specific applications for all rock types, hardness' s and conditions Bit life and rate of penetration are the most important criteria in selecting the right bit for a particular application.

Bit Face Shape Selection



Drop Center

For high penetration rates in soft to medium hard and fissured rock formations. Low to medium air pressures. Maximum hole deviation control.



Concave Face

The all-round application bit face specifically for medium hard and homogenous rock formations. Good hole deviation control and good flushing capacity.



Convex Face

For high penetration rates in soft to medium-hard with low to medium air pressures. It is the most resistance to steel wash, and may reduce the load and wear on the gauge buttons, but poor hole deviation control.



Double Gauge Face

This kind of face shape is suitable for fast penetration rates in medium to hard rock formations. Designed for high air pressures and good resistance to steel wash step gauge bit.



Flat Face

This kind of face shape is suitable for hard to very hard and abrasive rock formations in applications with high air pressures. Good penetration rates an resistance to steel wash.



Pineapple Face

The Pineapple Bit can be dressed with ballistic buttons for use in soft to medium hard formations where fractured rock can be expected, or can be supplied with spherical buttons for hard and abrasive formations.

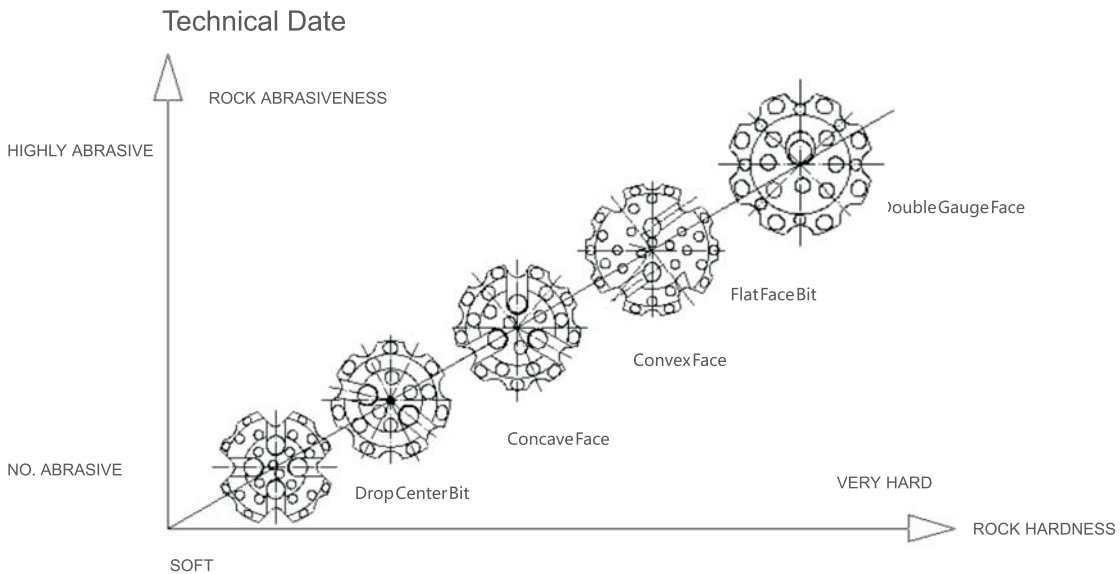

Carbide Button Shape Selection



Round Button



Semi-Ballistic Buttons



Ballistic Button



Flat Button



Sharp Button

Product codes

Product codes are a valuable tool to describe and identify the product. In the code structure we have tried to describe the product features with Coding system and not always 100% logical, but with the attached key you will be able find the product you are looking for or and alternative product.

Example A: HQL80-229FFDGR12-TPD-20

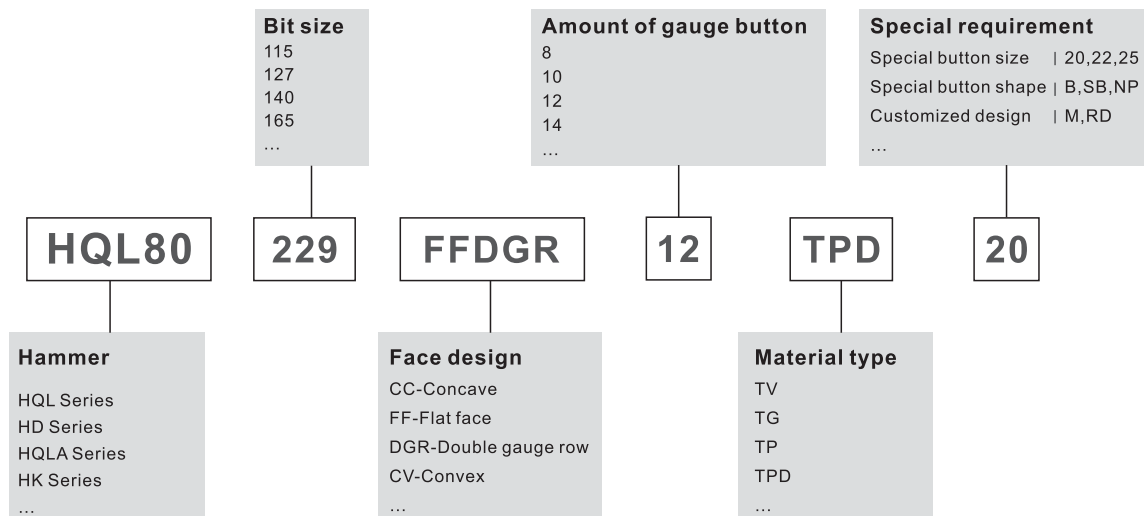

Bit shanks

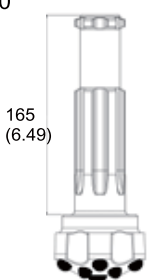
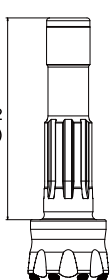
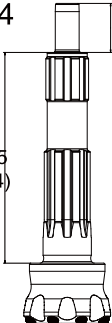
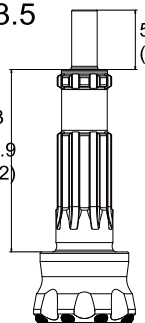
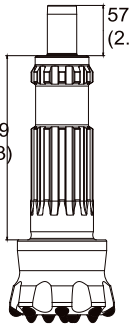
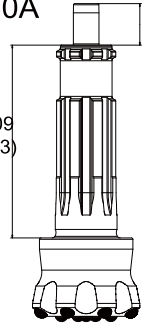
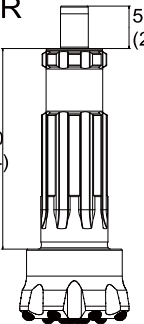
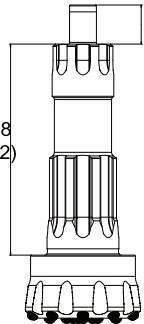
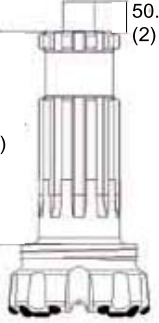
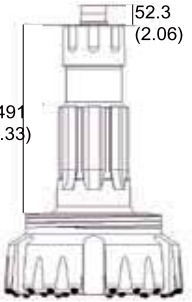
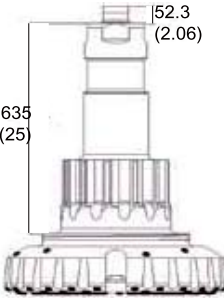
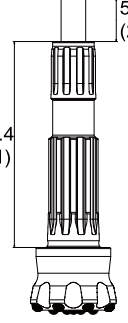
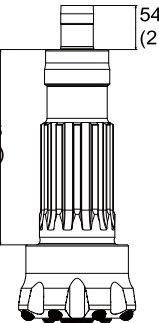
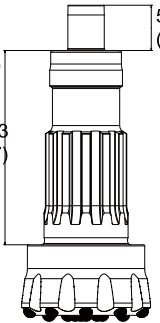
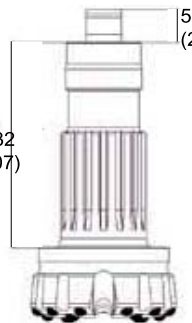
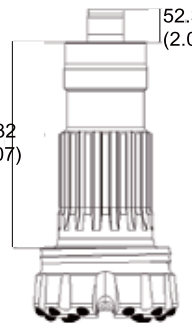
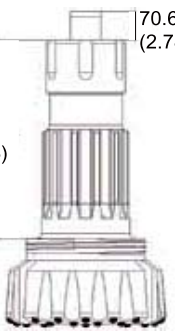
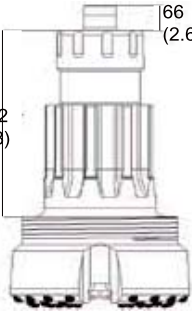
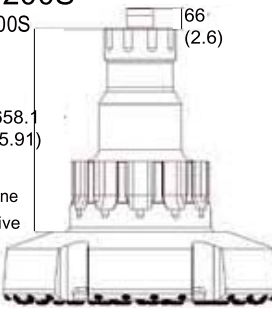
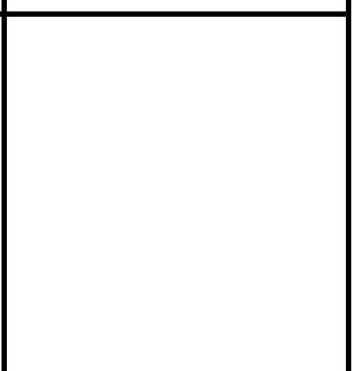
<p>BR 2 COP 20</p>  <p>165 (6.49)</p> <p>6 spline</p>	<p>COP 32 COP 32</p>  <p>215.2 (8.47)</p> <p>8 spline</p>	<p>COP 34 COP 34</p>  <p>57 (2.24)</p> <p>245 (9.64)</p> <p>8 spline</p>	<p>DHD 3.5 COP 35 TD 35.2 QLX 35 DHD 3.5 Terranox 3</p>  <p>58.9 (2.32)</p> <p>180.9 (7.12)</p> <p>8 spline</p>
<p>TD 40 COP 44 G QLX 40</p>  <p>57 (2.24)</p> <p>209 (8.23)</p> <p>12 spline</p>	<p>DHD 340A COP 44 DHD 4 QL 340 Terranox 4</p>  <p>45 (1.77)</p> <p>209 (8.23)</p> <p>8 spline</p>	<p>DHD 350R COP 54 DHD 5 Terranox 5</p>  <p>55 (2.17)</p> <p>260 (10.24)</p> <p>8 spline</p>	<p>DHD 360 COP 64 DHD 6 Terranox 6</p>  <p>57 (2.24)</p> <p>308 (12.12)</p> <p>8 spline</p>
<p>DHD 380 DHD 8 Terranox 8</p>  <p>50.8 (2)</p> <p>350 (13.78)</p> <p>10 spline</p>	<p>DHD 112 DHD 112</p>  <p>52.3 (2.06)</p> <p>491 (19.33)</p> <p>8 spline Pin drive</p>	<p>DHD 112S DHD 112S</p>  <p>52.3 (2.06)</p> <p>635 (25)</p> <p>12 spline Pin drive</p>	<p>QL 40 QL 40</p>  <p>58.4 (2.3)</p> <p>279.4 (11)</p> <p>10 spline</p>
<p>QL 50 QL 50 TD 50 COP 54 G</p>  <p>54.1 (2.13)</p> <p>239.6 (21.68)</p> <p>12 spline</p>	<p>QL 60 QL 60 TD 60/65/70 COP 64 G</p>  <p>59 (2.32)</p> <p>253.3 (9.97)</p> <p>12 spline</p>	<p>QL 80 QL 80 TD 80 TD 85</p>  <p>52.3 (2.05)</p> <p>332 (13.07)</p> <p>16 spline</p>	<p>TD 90 TD 90</p>  <p>52.3 (2.06)</p> <p>332 (13.07)</p> <p>16 spline</p>
<p>QL 120 QL 120</p>  <p>70.6 (2.78)</p> <p>491 (19.33)</p> <p>12 spline Pin drive</p>	<p>QL 200 QL 200</p>  <p>66 (2.6)</p> <p>492.2 (19.38)</p> <p>9 spline Pin drive</p>	<p>QL 200S QL 200S</p>  <p>66 (2.6)</p> <p>658.1 (25.91)</p> <p>12 spline Pin drive</p>	

3" BIT Data Referenced By IR3.5 Flat Face Bit



★ Specification Of Products : IR3.5



Specification Of Products : M30

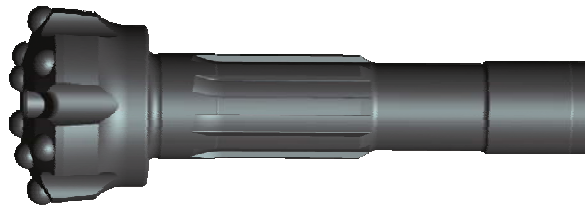

Specification Of Products : COP32

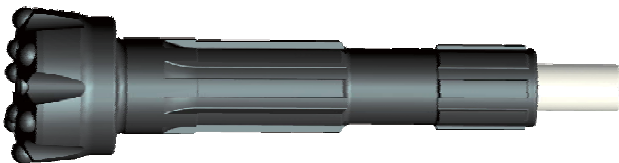

Specification Of Products : QL30, COP34

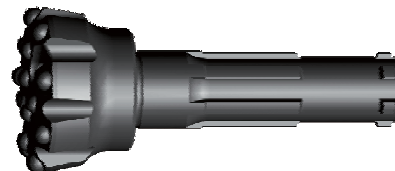

Specification Of Products : BR3

Diameter		No x Button diameter , mm		Button angle°	Flushing holes	Weight (Kg)	Part No
mm	inch	Gauge Buttons	Front Buttons				
90	3 9/16	8x12	7x11	38	2	4.6	HD35-90
92	3 5/8	8x12	7x11	38	2	4.6	HD35-92
95	3 3/4	8x12	7x11	38	2	4.7	HD35-95
100	3 15/16	8x12	7x12	38	2	4.8	HD35-100
105	4 1/8	8x14	7x12	38	2	5.0	HD35-105
110	4 5/16	8x14	7x12	38	2	5.5	HD35-110

4" BIT Data Referenced By DHD340A Flat Face Bit

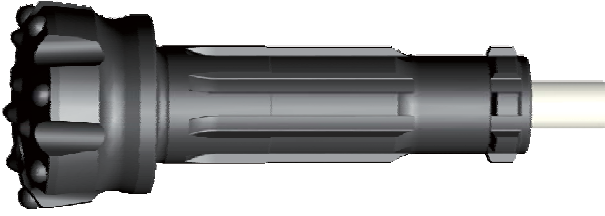

★ Specification Of Products : DHD340A
COP44



Specification Of Products : M40



Specification Of Products : SD4

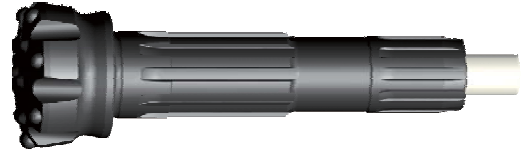

Specification Of Products : QL40

Diameter		No x Button diameter , mm		Button angle°	Flushing holes	Weight (Kg)	Part No
mm	inch	Gauge Buttons	Front Buttons				
105	4 1/8	8x14	7x12	38	2	7.6	HD45-105
110	4 5/16	8x14	7x12	38	2	7.8	HD45-110
115	4 1/2	8x14	7x13	38	2	8.2	HD45-115
120	4 3/4	8x14	8x13	38	2	8.7	HD45-120
125	4 15/16	8x14	10x13	38	2	8.9	HD45-125
130	5 1/8	8x16	8x14	38	2	9.4	HD45-130

5" BIT Data Referenced By DHD350R Flat Face Bit



★ Specification Of Products : DHD350R
COP54



Specification Of Products : M50



Specification Of Products : SD5



Specification Of Products : QL50

Diameter		No x Button diameter , mm		Button angle°	Flushing holes	Weight (Kg)	Part No
mm	inch	Gauge Buttons	Front Buttons				
130	5 1/8	8x16	8x14	38	2	15	HD55-130
135	5 1/4	8x16	8x14	38	2	15.2	HD55-135
138	5 1/2	8x16	10x14	38	2	15.6	HD55-138
140	5 1/2	8x16	10x14	38	2	15.8	HD55-140
146	5 3/4	8x18	8x15	38	2	16.1	HD55-146
150	5 7/8	8x18	8x15	38	2	16.5	HD55-150
152	6	8x18	8x15	38	2	17	HD55-152
156	6 1/8	8x18	8x16	38	2	17.5	HD55-156

6" BIT Data Referenced By DHD360R Concave Face Bit

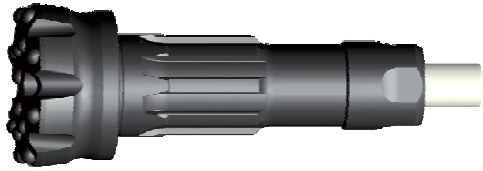

★ Specification Of Products : DHD360
COP64

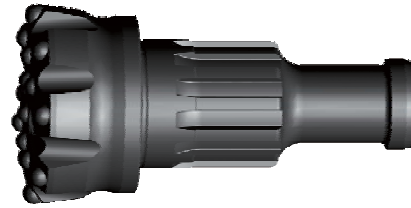

Specification Of Products : M60



Specification Of Products : SD6



Specification Of Products : QL60

Diameter		No x Button diameter , mm		Button angle°	Flushing holes	Weight (Kg)	Part No
mm	inch	Gauge Buttons	Front Buttons				
152	6	8x18	4x16+4x14	38	2	23	HD65-152
154	6	8x18	4x16+4x14	38	2	23	HD65-154
156	6 1/4	8x18	4x16+4x14	38	2	23	HD65-156
159	6 1/4	8x18	4x16+4x14	38	2	23.5	HD65-159
165	6 1/2	8x18	8x16	38	2	24	HD65-165
171	6 3/4	8x18	8x16	38	2	25	HD65-171
178	7	8x18	10x16	38	2	26	HD65-178
185	7 1/4	8x18	10x16	38	2	26.8	HD65-185
190	7 1/2	10x18	13x16	38	2	27.5	HD65-190
203	8	10x18	8x18+6x16	38	2	31	HD65-203

8" BIT Data Referenced By DHD380 Concave Face Bit



★ Specification Of Products : DHD380
COP84



Specification Of Products : M80

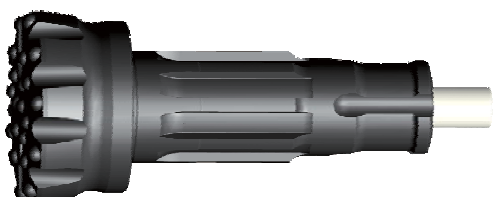

Specification Of Products : SD8

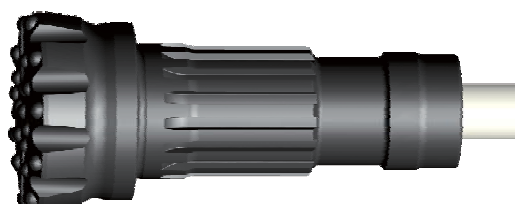

Specification Of Products : QL80

Diameter		No x Button diameter , mm		Button angle°	Flushing holes	Weight (Kg)	Part No
mm	inch	Gauge Buttons	Front Buttons				
200	7 7/8	10x18	8x18+6x16	38	2	46	HD85-200
203	8	10x18	8x18+6x16	38	2	47	HD85-203
216	8 1/2	10x18	8x18+6x16	38	2	53	HD85-216
219	8 5/8	10x18	8x18+6x16	38	2	54	HD85-219
222	8 3/4	10x18	8x18+6x16	38	2	55	HD85-222
225	8 7/8	10x18	8x18+7x16	38	2	56	HD85-225
229	9	10x18	8x18+7x16	38	2	57	HD85-229
235	9 1/4	12x18	30x16	38	2	57.5	HD85-235
240	9 1/2	12x18	30x16	38	2	58	HD85-240
254	10	12x18	12x18+8x16	38	2	61	HD85-254
270	10 5/8	12x19	20x18+8x16	38	2	66	HD85-270
279	11	12x19	20x18+9x16	38	3	71	HD85-279

Drill Pipe

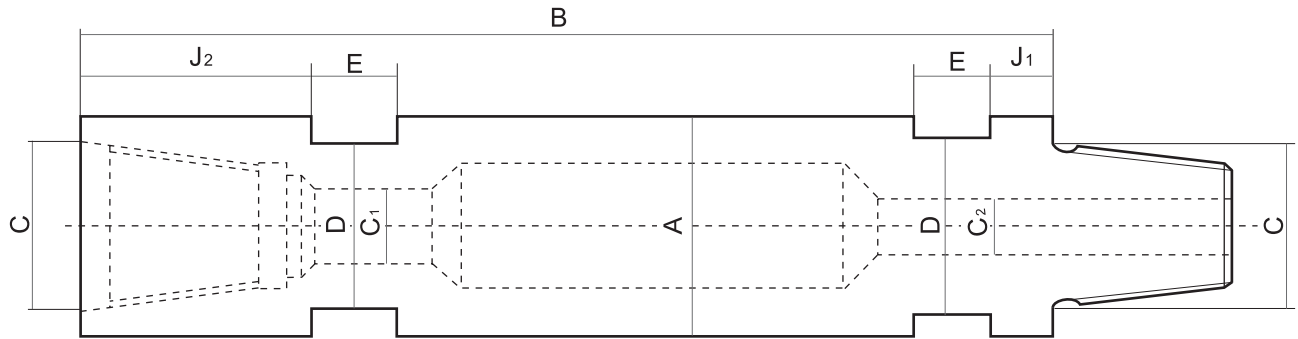

A OD(mm)	B Length SS	C1 Joints type	C2 Threat type	D Across flat	E Width spanner flat	F Thickness
76	1500	box-pin	RD 50	65	38.1	5
89	1800	box-box	API 2 3/8" Reg	69.8	60.3	6
102	3000	pin-pin	API 3 1/2" Reg	63.5	50.8	7.5
114	4000		API 4 1/2" Reg	92.2	69.8	8
127	5000		3 1/8" DIBH	120.6	...	10
140	6000		CUBEX#21	130.1		12
152	7500		CUBEX#24	...		14
...	9144		CUBEX#28			...
...

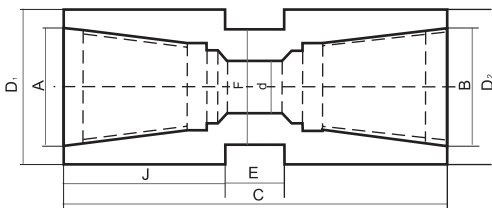

Box-Box Adapters

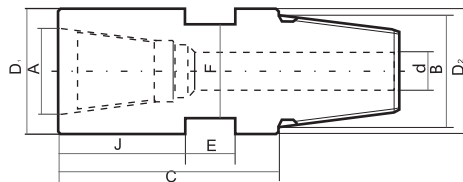

Pin-Box Adapters

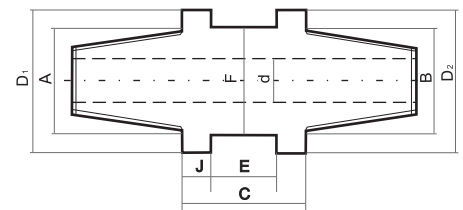

Pin-Pin Adapters

A-B Joints type	A1-B1 Threat type	C Length SS	D1 OD	D2 OD	E Width spanner flat	F Across flat
box-pin	RD 50	1500	76	76	38.1	65
box-box	API 2 3/8" Reg	1800	89	89	60.3	69.8
pin-pin	API 3 1/2" Reg	3000	102	102	50.8	63.5
	API 4 1/2" Reg	4000	114	114	69.8	92.2
	3 1/8" DIBH	5000	127	127	...	120.6
	CUBEX#21	6000	140	140		130.1
	CUBEX#24	7500	152	152		...
	CUBEX#28	9144
	BECO

Breakout Bench

The threaded connections of the driver chuck and top sub may become very tightly tensioned during drilling. It is convenient to break the hammer threads on the rig, but if the threads cannot be loosened or tend to get stuck, a breakout bench is the solution. This handy but powerful breakout bench can easily be placed in a workshop or container and it breaks DTH hammers between 3" and 10" Select right breakout bench depending on voltage and power source.



Available for hammer size 6"~12"

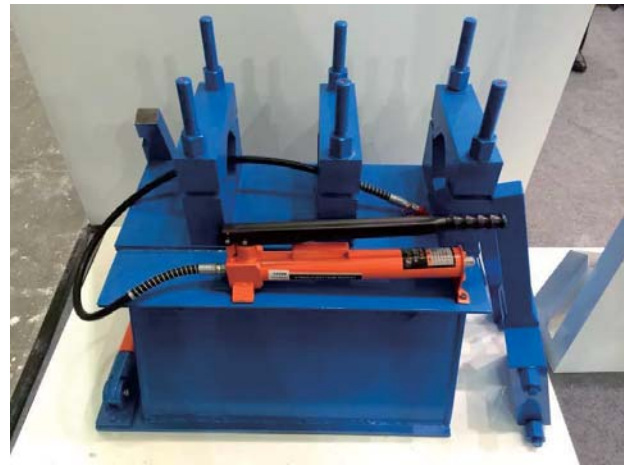

Technical Data: rpm of chain less than 10tums/m velocity of piston rod 1.8meter/m

Hammer Range	Overall dimensions (length*width*depth)	Weight	Maximum assembly torque
3.5"-10"	1600*930*1050mm	800Kg	67 KN*m(50ftlb)
Maximum disassembly torque	Operating Height	Hydraulic Range	Power
81 KN*m(60ftlb)	800mm	0-20Mpa	3Kw,220V,50Hz